

## DOORS

# AMBIAL

## THE VERSATILE FOLDING DOOR

AMBIAL is a folding door that is ideal for large openings, in a straight line design or around a corner.

### Performance

- 75 mm frame width. 2 vent heights available:
  - 66 mm in standard version
  - 76 mm in reinforced version for large dimensions
- Glazing thickness from 9 to 59 mm
- 3-point locking system with insulated key
- Treshold:
  - Standard double brush
  - Flush mounted treshold for accessibility
  - Treshold with rebate for improved performance
- Max. dimensions: W x H 1200 x 3000 mm per leaf, i.a. a maximum width of 12 m
- Min. dimensions: H frame 572 mm, W leaf 600 mm/ W door leaf 670 mm
- Max leaf weight up to 150 kg
- Available in Burglar protection class RC2, straight line version 1 up to 10 sashes.

### Design

- Wide choice of configurations: from 1 up to 10 leaf, straight line version or open corner version, inwards or outwards opening from the center or one of the sides
- Mullion, cover profiles and specific accessories are designed to create a 90° angled inwards or outwards opening with floating mullion
- Completely flush appearance in closed position, straight lines and visual harmony in closed position
- Concealed drainage in all applications
- Blocking magnets to protect the door from any shocks when in the open position
- Ultra-flat handle and key design
- Pull handle mounted on hinges or on support for easy closure
- Opening versions: inward or outward opening

### Low carbon footprint

AMBIAL is made from Hydro CIRCAL<sup>®</sup>, recycled low carbon aluminium. That means it's high quality aluminium made with a minimum of 75% recycled end-of-life aluminium (post-consumer scrap). Hydro CIRCAL<sup>®</sup> has a carbon footprint of 2.3 kg of CO<sub>2</sub>/kg of aluminium on average.

Thermal performances:  $U_w = 0.95 \text{ W/m}^2\text{K}$   
 ( $U_g = 0.5 \text{ W/m}^2\text{K}$ ) (5 leafs W 6000 mm x H 3000 mm)  
 Air permeability: Class 4  
 Watertightness: up to 450 Pa  
 Wind pressure resistance: Class C3  
 Operation force: Class 1 (less than 100 N)  
 Mechanical strength: Class 3  
 Corrosion resistant hardware: Grade 5 (420h in saline mist)  
 Endurance: 50000 cycles (3 leafs of 150 kg)  
 Acoustic attenuation: up to  $R_w[C;C_{tr}] 42\text{dB}(-1;-5)$   
 Burglar protection: Available in Burglar protection, class RC2.





**sapa:**

By  Hydro

## Applications

From 1 to 10 leaves, inward or outward opening with identical configuration

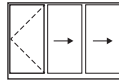
1 leaf	2 leaves	3 leaves	4 leaves	5 leaves	6 leaves	8 leaves	10 leaves
 101-i 110-i 101-e 110-e	 211-i 211-e	 303-i 330-i 303-e 330-e	413-i 431-i 413-e 431-e	505-i 550-i 505-e 550-e	615-i 651-i 633-i 615-e 651-e 633-e	835-i 853-i 835-e 853-e	1055-i 1055-e

3 leaves,  
outward opening

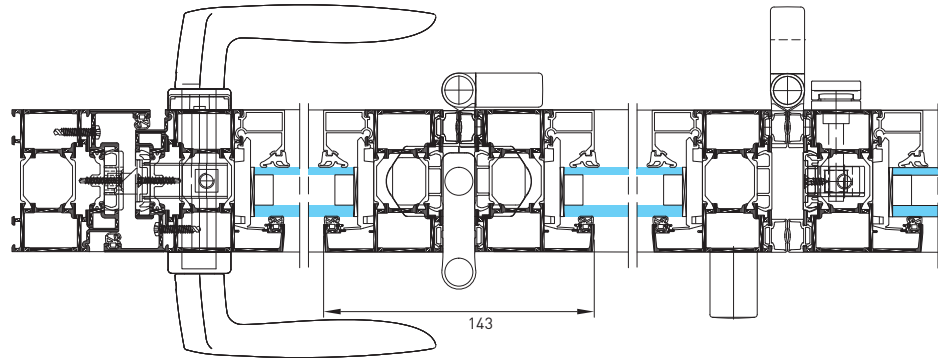

From 2 to 10 leaves in corner solution, inward or outward opening with identical configuration

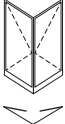
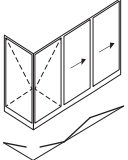
1 leaf in corner	1x3 leaves in corner	3x3 leaves in corner	1x5 leaves in corner	3x5 leaves in corner	5x5 leaves in corner
 AS-211-i AS-211-e	 AS-413-i AS-431-i AS-413-e AS-431-e	AS-633-i AS-633-e	AS-615-i AS-651-i AS-615-e AS-651-e	AS-835-i AS-853-i AS-835-e AS-853-e	AS-1055-i AS-1055-e

3x3 leaves,  
outward opening  
in corner

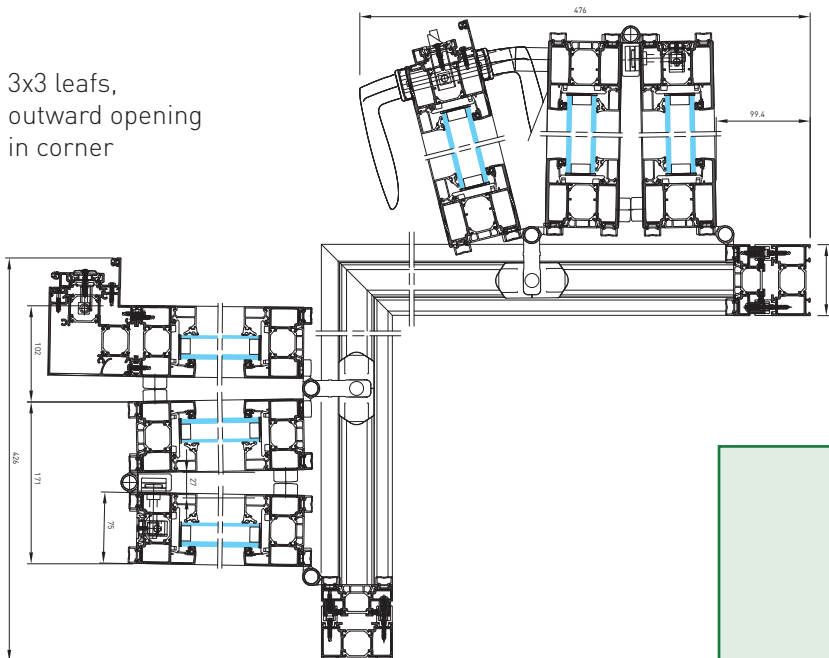

\* Article codes:

AS	outer corner
1 <sup>st</sup> digit	total n° of leaves
2 <sup>nd</sup> digit	n° of leaves on the left
3 <sup>rd</sup> digit	n° of leaves on the right
opening	i = inward / e = outward

Hardware for AMBIAL available in three colors,  
black RAL 9005, grey RAL 9006 or white RAL 9010.

- TPW6009 - flat handle
- TPW6002 - flat lockable handle
- TPW6006 - pull handle
- SCZ61025 - exterior handle
- SCZ61027 - handle for side hung door

Hydro Building Systems Lithuania UAB  
Kirtimų g. 47, Vilnius  
LT-02244, Lithuania  
[www.sapa.lt](http://www.sapa.lt)

**sapa:**

By  Hydro